

Fixed Frame Screen

User's Guide



PRE-INSTALLATION

1. Carefully unpack the contents of the screen.
2. Lay the frame and screen material on a clean surface to protect them from being damaged.

INSTALLING YOUR SCREEN

Note: This projection screen should be installed in a position where the audience has a best view of the image in order to achieve a clear picture.

Step 1: ASSEMBLING THE FRAME

1. Insert the metal round-shaped nails (D) through all four frames (A) as shown on Fig 1.

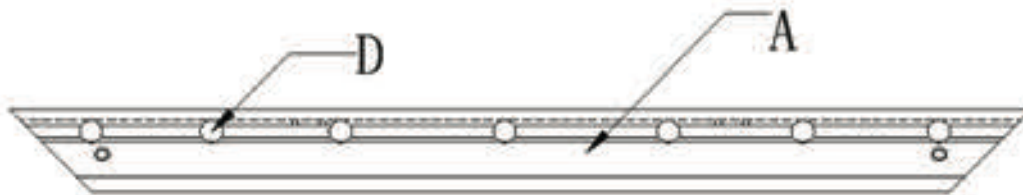

Fig. 1

2. Join the four frames (Ax2/Bx2) together with one another at the corresponding angles using part (C).
3. Adjust the screws (H) on the corners to form a firm quadrangle having four right angles.
3. Tighten the screws (H) in firmly to secure the frame on all four corners.

Note: Make sure the corners are evenly aligned on all four corners before proceeding to the next step.

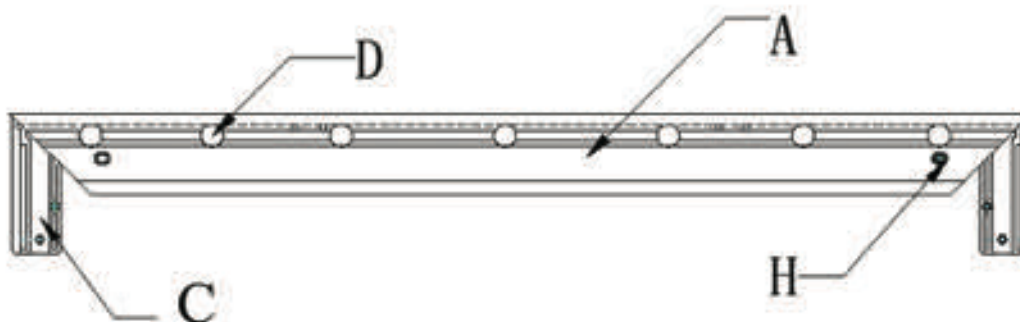

Fig. 2

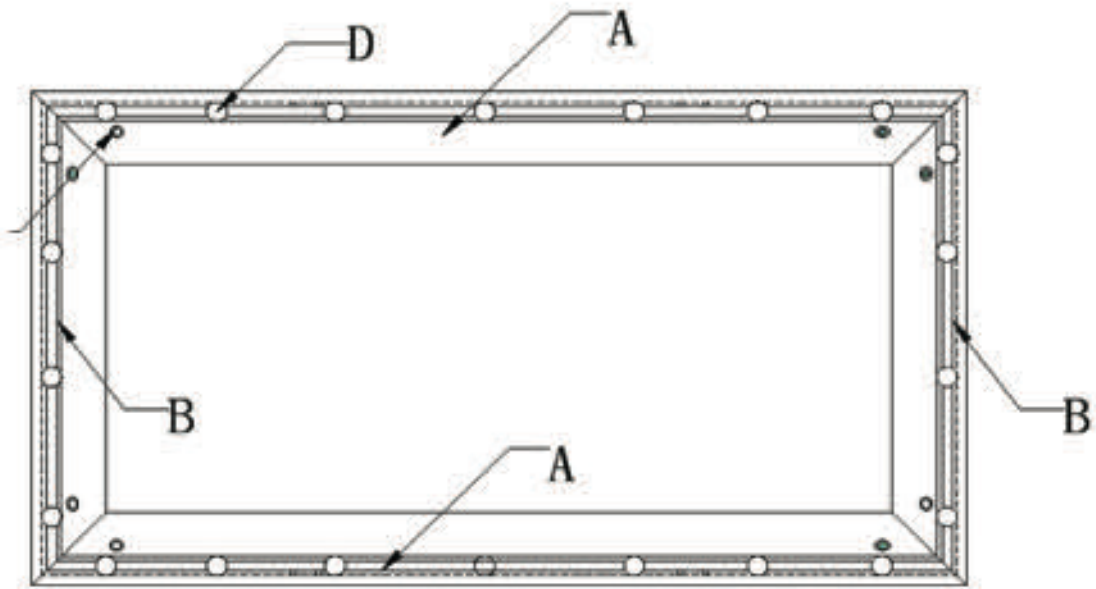

Fig. 3

Step 2: PREPARING THE SCREEN MATERIAL

1. Lay out the screen material on a clean surface in full length and insert the metal bars (E_{x2}F_{x2}) through the corresponding margins of the screen (J).

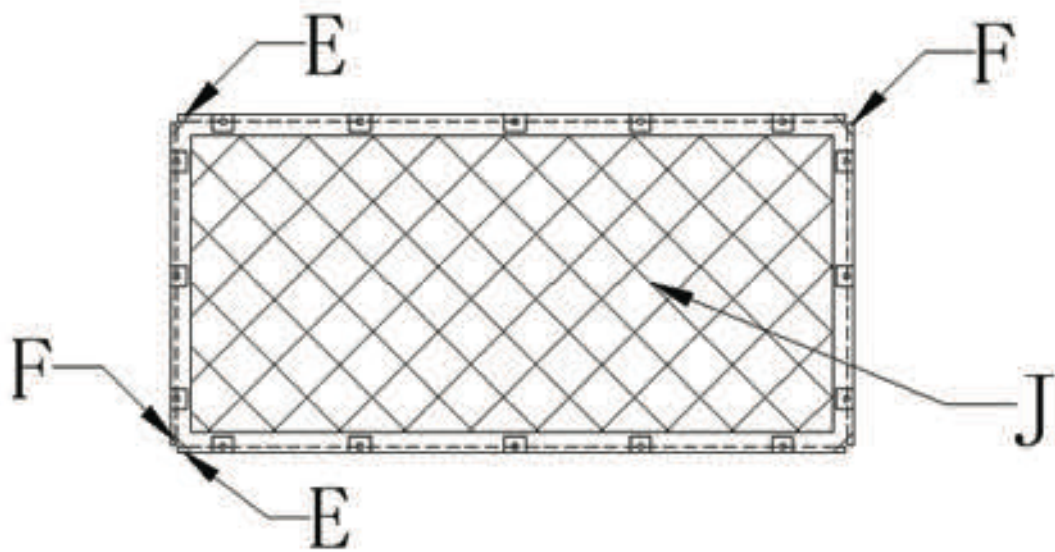

Fig. 4

2. Place the screen material in the center of the back of the frame to allow an equal amount of stretch on all sides.

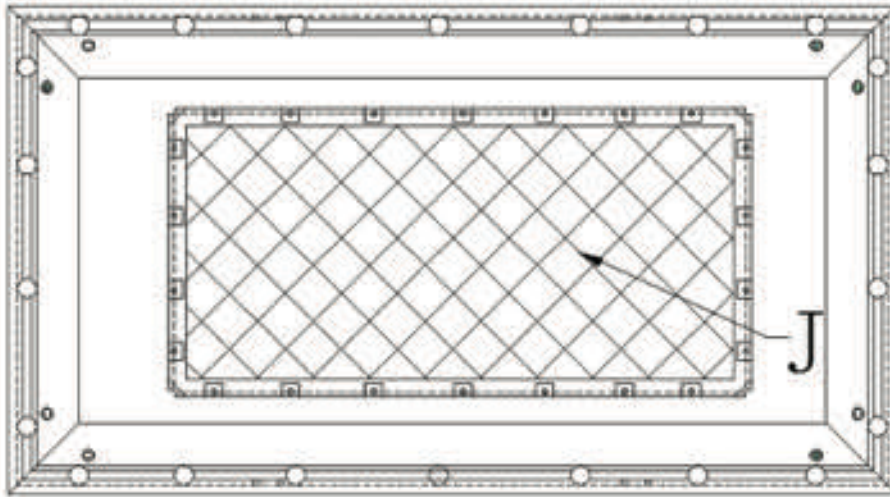

Fig. 5

Step 3: INSTALLING THE SCREEN MATERIAL

1. Begin by installing the screen material on the center two holes on the **(D)** nails located on the left and right sides of the frame as shown on Fig. 6.

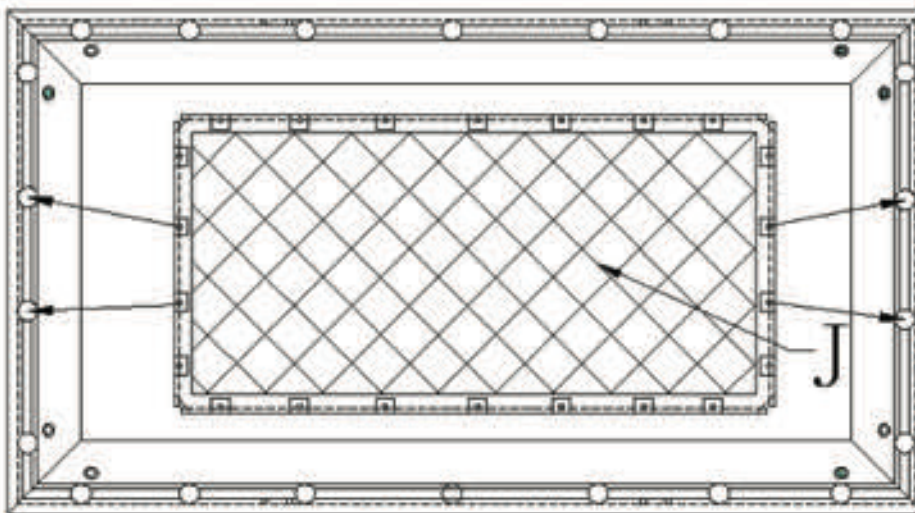

Fig. 6

2. Repeat the same procedure above to the top and bottom sides as shown on Fig. 7.

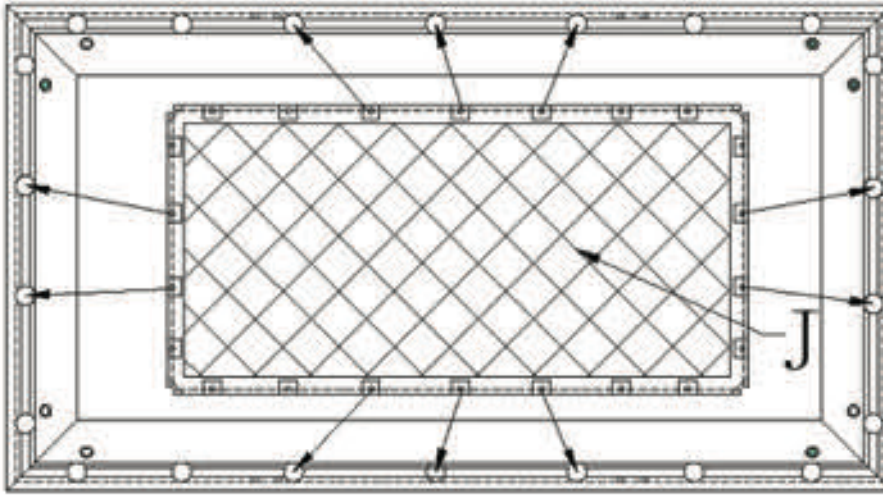

Fig. 7

3. Lastly, install the four remaining corners to complete assembling your fixed frame screen.

Step 4: MOUNTING HARDWARE

2. Install the screws (I) to secure the mount metal mount plate.
3. Mount your fixed frame screen at the desired location

Fig. 8

WARNING:

The projection screen frame is made of high-quality aluminum alloy and should be handled with care. Use a soft cloth with warm water to remove any marks on the screen surface. Never attempt to use any solutions, chemicals or abrasive cleaners on the screen surface. Never attempt to touch screen with your fingers or a sharp object to avoid damaging the screen material.

PARTS LIST:



A x 2



B x 2

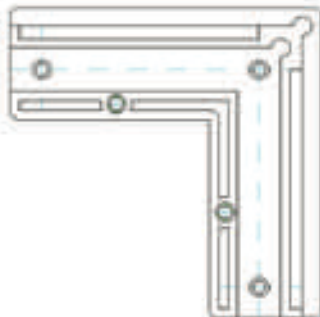

C x 2



D x 20-30



E x 2



F x 2



H (M5X15) x 8

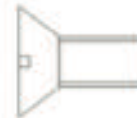

I (M5X8) x 4

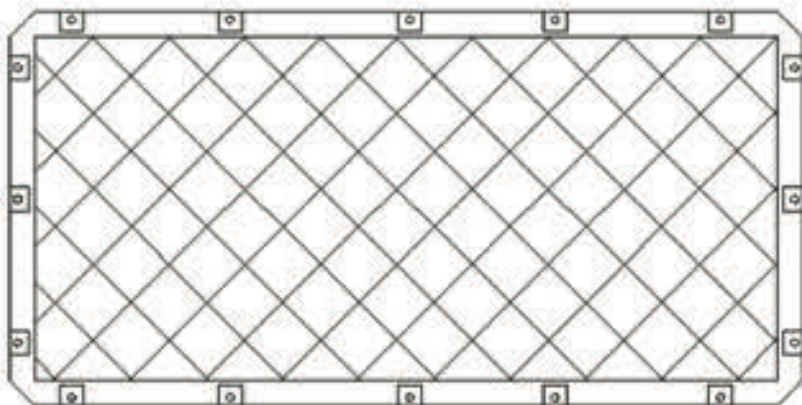

J x 1

NOTE:

Regardless of mounting method, screen should be securely supported so that vibration will not cause case to work loose or fall. Installer must insure that fasteners used are of adequate strength and suitable for the mounting surface chosen.